

MarCator 1075 R

Digital Indicator



FUNCTIONS

- ON/OFF
- RESET (set display to zero)
- mm/inch
- Reversal of counting direction
- PRESET (for entering a numerical value)
- DATA (data transmission via connection cable)
- LOCK function (key lock)
- AUTO-ON / OFF



FEATURES

- High contrast LCD
- Hermetically sealed protective measuring spindle cap
- Mounting shank and measuring spindle are both made of hardened stainless steel
- **Digit height:** 12 mm
- **Data interface:** Digimatic, Opto RS232C, USB
- **Energy supply:** Battery life approx. 3 years
- **IP protection category:** IP 52
- **Package contains:** battery, instruction manual

Application:

Simple measuring function for **static measurements** such as lengths, distances and length differences

TECHNICAL DATA

Order no.	4336010	4336020	4336030
Product type		1075 R	
Measuring span	mm	12.5	
Measuring span	inch	.5"	
Resolution	mm	0.01	0.001
Resolution	inch	.0005"	.00005"
Error limit	mm	0.02	0.015
Measuring force	N		0.5 – 1
Standard			Factory standard
Protective measuring spindle cap			•

Order no.	Mounting shaft
	mm
4336010	8
4336020	8
4336030	8

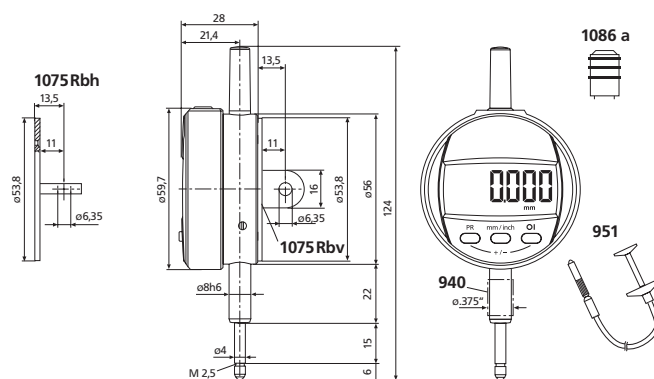

ACCESSORIES

Order no.	Product name	Product type
4102357	16 EXu Data connection cable USB (2 m)	16 EXu
4102915	Digimatic data cable (2 m)	16 EWd
4102410	Data connection cable RS232C (2 m)	16 EXr
4310103	Adapter bush (.375" / 8 mm)	940
4372000	Cable release (250 mm)	951
4375004	Protective cap for 1075 R / 1086 R / 1087 R	1086 s
4337320	Lift-off cap, complete 12.5 / 25 mm	
4336041	Lug back, horizontal	1075 Rbh
4336042	Lug back, vertical	1075 Rbv
4102520	Battery 3 V, CR 2032	

MarCator 1086 R / 1086 ZR

Digital Indicator



FUNCTIONS

- ON/OFF
- RESET (set display to zero)
- mm/inch
- Reversal of counting direction
- PRESET (for entering a numerical value)
- TOL (enter tolerance limit values)
- <0> (tolerance GO / NO GO display mode)
- ABS (display can be set to zero without losing reference to preset)
- DATA (data transmission via connection cable)
- Factor (adjustable)
- LOCK (individual key lock)

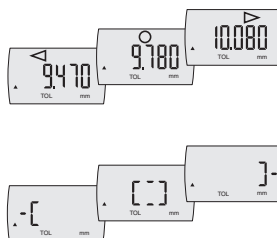

FEATURES

- High contrast LCD
- Operating and display unit (bezel) can be rotated through 280°
- Lifter protection cap on the measuring spindle
- Mounting shank and measuring spindle are both made of hardened stainless steel
- Immediate measurements due to the Reference System
- **Digit height:** 11 mm
- **Data interface:** Digimatic, Opto RS232C, USB
- **Energy supply:** Battery life approx. 3 years
- **IP protection category:** IP 42
- **Package contains:** instruction manual, battery

TECHNICAL DATA

Order no.	4337620		4337621		4337622		4337623		4337650		4337651	
Type	1086 R						1086 ZR					
Measuring span	mm	12.5	25	50	100	12.5	25	mm	inch	.5"	1"	2"
Numerical increment	mm	0.0005, 0.001, 0.002, 0.005, 0.01										
Numerical increment	inch	.00002", .00005", .0001", .0002", .0005"										
Error limit	mm	0.004		0.007		0.008		0.004				
Error limit over 50 graduations	mm	0.002										
Repeatability	mm	0.001										
Measuring force	N	0.65 - 0.9	0.65 - 1.15	1.25 - 2.7	1.8 - 3.5	0.65 - 0.9	0.9 - 1.15					
Standard	Factory standard											

Order no.	a	b	c	Mounting shaft	Mounting shaft
	mm	mm	mm	mm	inch
4337620	126.3	23	13.5	8	
4337621	153.4	26.8	26.5	8	
4337622	267.3	40	52	8	
4337623	420.3	91	103	8	
4337650	126.3	23	13.5		.375"
4337651	153.4	26.8	26.5		.375"

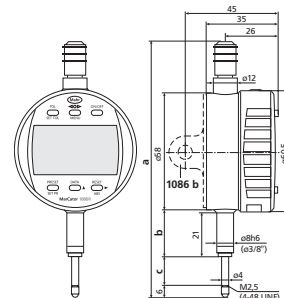

ACCESSORIES

Order no.	Product name	Product type
2246308	Adjustable back	
2254939	Screw back	
2255653	Rack back	
2255778	Adjustable back for 75B	
2255936	Post back	
4102357	16 EXu Data connection cable USB (2 m)	16 EXu
4102915	Digimatic data cable (2 m)	16 EWd
4102410	Data connection cable RS232C (2 m)	16 EXr
4375004	Protective cap for 1075 R / 1086 R / 1087 R	1086 s
4337421	Lug back	1086 b
4336311	Cable release (12.5 + 25 mm)	1085 a
4336237	Pneumatic lifting (12.5 + 25 mm)	1082 p
4310103	Adapter bush (.375" / 8 mm)	940
4884464	Battery 3 V, type CR 2450	
4336230	Pneumatic lifting (50 + 100 mm)	1082 p

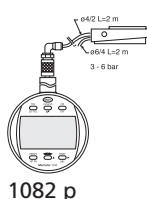
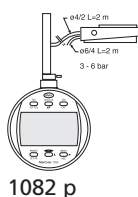

MarCator 1086 R

Digital Indicator



FUNCTIONS

- ON/OFF
- RESET (set display to zero)
- mm/inch
- Reversal of counting direction
- PRESET (for entering a numerical value)
- TOL (enter tolerance limit values)
- <0> (tolerance GO / NO GO display mode)
- ABS (display can be set to zero without losing reference to preset)
- DATA (data transmission via connection cable)
- Factor (adjustable)
- LOCK (individual key lock)

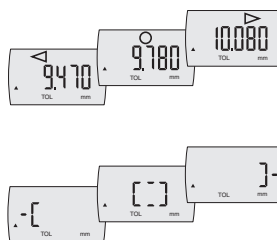

Application:

Comprehensive measuring function for static measurements such as lengths, distances and length differences

FEATURES

- High contrast LCD
- Operating and display unit (bezel) can be rotated through 280°
- Lifter protection cap on the measuring spindle
- Mounting shank and measuring spindle are both made of hardened stainless steel
- Immediate measurements due to the Reference System
- **Digit height:** 11 mm
- **Data interface:** Digimatic, Opto RS232C, USB
- **Energy supply:** Battery life approx. 3 years
- **IP protection category:** IP 42
- **Package contains:** instruction manual, battery

TECHNICAL DATA

Order no.	4337130	4337131	4337132	4337133	
Product type	1086 R				
Measuring span	mm	12.5	25	50	100
Measuring span	inch	.5"	1"	2"	4"
Resolution	mm	0.01			
Resolution	inch	.0005"			
Error limit	mm	0.02			
Error limit over 50 graduations	mm	0.02			
Repeatability	mm	0.01			
Measuring force	N	0.65 – 0.9	0.65 – 1.15	1.25 – 2.7	1.6 – 3.5
Standard	Factory standard				
Lifting protection cap	•				

Order no.	a	b	c	Mounting shaft
	mm	mm	mm	mm
4337130	126.3	23	13.5	8
4337131	153.4	26.8	26.5	8
4337132	267.3	40	52	8
4337133	420.3	91	103	8

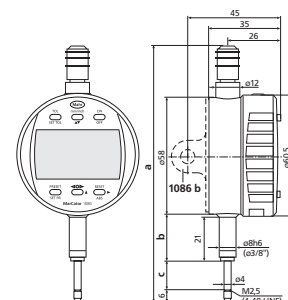

ACCESSORIES

Order no.	Product name	Product type
2246308	Adjustable back	
2254939	Screw back	
2255653	Rack back	
2255778	Adjustable back for 75B	
2255936	Post back	
4102357	16 EXu Data connection cable USB (2 m)	16 EXu
4102915	Digimatic data cable (2 m)	16 EWd
4102410	Data connection cable RS232C (2 m)	16 EXr
4375004	Protective cap for 1075 R / 1086 R / 1087 R	1086 s
4337421	Lug back	1086 b
4336237	Pneumatic lifting (12.5 + 25 mm)	1082 p
4336311	Cable release (12.5 + 25 mm)	1085 a
4310103	Adapter bush (.375" / 8 mm)	940
4884464	Battery 3 V, type CR 2450	
4336230	Pneumatic lifting (50 + 100 mm)	1082 p

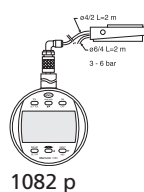
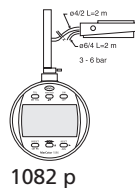

MarCator 1086 WR

Digital Indicator



FUNCTIONS

- ON/OFF
- RESET (set display to zero)
- mm/inch
- Reversal of counting direction
- PRESET (for entering a numerical value)
- TOL (enter tolerance limit values)
- <0> (tolerance GO / NO GO display mode)
- ABS (display can be set to zero without losing reference to preset)
- DATA (data transmission via connection cable)
- Factor (adjustable)
- LOCK (individual key lock)

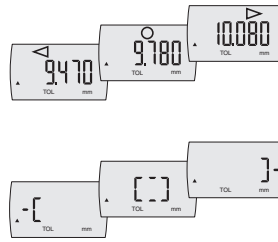

Application:

Comprehensive measuring function for static measurements such as lengths, distances and length differences

FEATURES

- High contrast LCD
- Operating and display unit (bezel) can be rotated through 280°
- Protection cap on the end of measuring spindle
- Mounting shank and measuring spindle are both made of hardened stainless steel
- Immediate measurements due to the Reference System
- **Digit height:** 11 mm
- **Data interface:** Digimatic, Opto RS232C, USB
- **Energy supply:** Battery life approx. 3 years
- **IP protection category:** IP 54
- **Package contains:** instruction manual, battery

TECHNICAL DATA

Order no.	4337640	4337641
Product type	1086 WR	
Measuring span	mm 12.5	25
Measuring span	inch .5"	1"
Resolution	0.0005, 0.001, 0.002, 0.005, 0.01	
Resolution	.00002", .00005", .0001", .0002", .0005"	
Error limit	0.004	
Error limit over 50 graduations	0.002	
Repeatability	0.001	
Measuring force	N 0.65 – 1.4	1 – 2.25
Standard	Factory standard	
Protective measuring spindle cap	•	

Order no.	a	b	c	Mounting shaft
	mm	mm	mm	mm
4337640	144.3	21	28.5	8
4337641	193.2	24.8	50	8

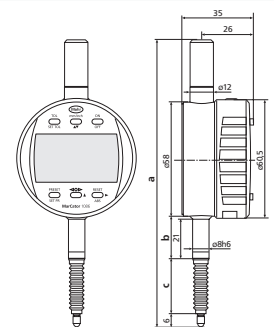

ACCESSORIES

Order no.	Product name	Product type
2246308	Adjustable back	
2254939	Screw back	
2255653	Rack back	
2255778	Adjustable back for 75B	
2255936	Post back	
4102357	16 EXu Data connection cable USB (2 m)	16 EXu
4102915	Digimatic data cable (2 m)	16 EWd
4102410	Data connection cable RS232C (2 m)	16 EXr
4375004	Protective cap for 1075 R / 1086 R / 1087 R	1086 s
4337421	Lug back	1086 b
4336311	Cable release (12.5 + 25 mm)	1085 a
4336237	Pneumatic lifting (12.5 + 25 mm)	1082 p
4337472-E	Rubber bellows (12.5 mm)	
4310103	Adapter bush (.375" / 8 mm)	940
4884464	Battery 3 V, type CR 2450	
4337474-E	Rubber bellows (25 mm)	

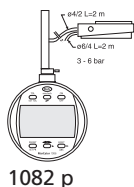
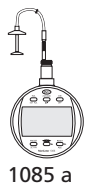

MarCator 1086 Ri

Digital Indicator



FUNCTIONS

- ON/OFF
- RESET (set display to zero)
- mm/inch
- Reversal of counting direction
- PRESET (for entering a numerical value)
- TOL (enter tolerance limit values)
- <0> (tolerance GO / NO GO display mode)
- ABS (display can be set to zero without losing reference to preset)
- DATA (data transmission via connection cable)
- Factor (adjustable)
- LOCK (individual key lock)

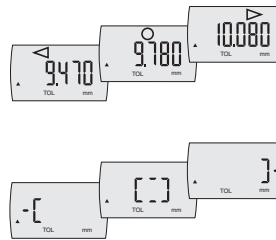

Application:

Comprehensive measuring function for static measurements such as lengths, distances and length differences

FEATURES

- Integrated wireless transmitter
- High contrast LCD
- Operating and display unit (bezel) can be rotated through 280°
- Mounting shank and measuring spindle are both made of hardened stainless steel
- Immediate measurements due to the Reference System
- **Digit height:** 11 mm
- **Data interface:** Digimatic, Opto RS232C, USB, Integrated wireless
- **IP protection category:** IP 42
- **Package contains:** instruction manual, battery

TECHNICAL DATA

Order no.		4337624	4337625	4337626	4337627	4337628
Product type		1086 Ri				
Measuring span	mm	12.5	25	50	100	25
Measuring span	inch	.5"	1"	2"	4"	1"
Resolution	mm	0.0005, 0.001, 0.002, 0.005, 0.01				
Resolution	inch	.00002", .00005", .0001", .0002", .0005"				
Error limit	mm	0.004	0.007	0.008	0.008	0.004
Error limit over 50 graduations	mm	0.002				
Repeatability	mm	0.001				
Measuring force	N	0.65 - 0.9	0.65 - 1.15	1.25 - 2.7	1.8 - 3.5	0 - 0
Standard		Factory standard				
Lifting protection cap		•				

Order no.	a	b	c	Mounting shaft
	mm	mm	mm	mm
4337624	126.3	23	13.5	8
4337625	153.4	26.8	26.5	8
4337626	267.3	40	52	8
4337627	420.3	91	103	8
4337628	153.4	26.8	26.5	8

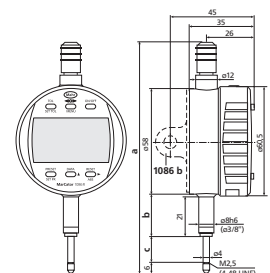

ACCESSORIES

Order no.	Product name	Product type
2246308	Adjustable back	
2254939	Screw back	
2255653	Rack back	
2255778	Adjustable back for 75B	
2255936	Post back	
4102220	Receiver for instruments with integrated wireless	i-Stick
4102357	16 EXu Data connection cable USB (2 m)	16 EXu
4102915	Digimatic data cable (2 m)	16 EWd
4102410	Data connection cable RS232C (2 m)	16 EXr
4375004	Protective cap for 1075 R / 1086 R / 1087 R	1086 s
4337421	Lug back	1086 b
4336311	Cable release (12.5 + 25 mm)	1085 a
4336237	Pneumatic lifting (12.5 + 25 mm)	1082 p
4310103	Adapter bush (.375" / 8 mm)	940
4884464	Battery 3 V, type CR 2450	
4336230	Pneumatic lifting (50 + 100 mm)	1082 p

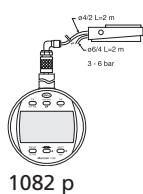
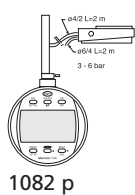

MarCator 1086 Ri

Digital Indicator



FUNCTIONS

- ON/OFF
- RESET (set display to zero)
- mm/inch
- Reversal of counting direction
- PRESET (for entering a numerical value)
- TOL (enter tolerance limit values)
- <0> (tolerance GO / NO GO display mode)
- ABS (display can be set to zero without losing reference to preset)
- DATA (data transmission via connection cable)
- Factor (adjustable)
- LOCK (individual key lock)

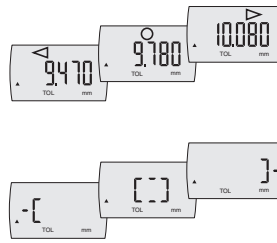

FEATURES

- Integrated wireless transmitter
- High contrast LCD
- Operating and display unit (bezel) can be rotated through 280°
- Mounting shank and measuring spindle are both made of hardened stainless steel
- Immediate measurements due to the Reference System
- Digit height: 11 mm
- Data interface: Digimatic, Opto RS232C, USB, Integrated wireless
- IP protection category: IP 42
- Package contains: instruction manual, battery

Application:

Comprehensive measuring function for static measurements such as lengths, distances and length differences

TECHNICAL DATA

Order no.		4337134	4337135
Product type			1086 Ri
Measuring span	mm	12.5	25
Measuring span	inch	.5"	1"
Resolution	mm		0.01
Resolution	inch		.0005"
Error limit	mm		0.02
Error limit over 50 graduations	mm		0.02
Repeatability	mm		0.01
Measuring force	N	0.65 – 0.9	0.65 – 1.15
Standard		Factory standard	
Lifting protection cap			•

Order no.	a	b	c	Mounting shaft
	mm	mm	mm	mm
4337134	126.3	23	13.5	8
4337135	153.4	26.8	26.5	8

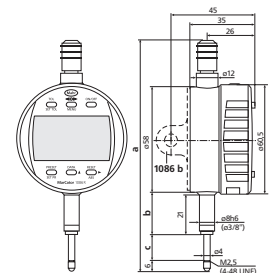

ACCESSORIES

Order no.	Product name	Product type
2246308	Adjustable back	
2254939	Screw back	
2255653	Rack back	
2255778	Adjustable back for 75B	
2255936	Post back	
4102220	Receiver for instruments with integrated wireless	i-Stick
4102357	16 EXu Data connection cable USB (2 m)	16 EXu
4102915	Digimatic data cable (2 m)	16 EWd
4102410	Data connection cable RS232C (2 m)	16 EXr
4375004	Protective cap for 1075 R / 1086 R / 1087 R	1086 s
4337421	Lug back	1086 b
4310103	Adapter bush (.375" / 8 mm)	940
4336311	Cable release (12.5 + 25 mm)	1085 a
4336237	Pneumatic lifting (12.5 + 25 mm)	1082 p
4884464	Battery 3 V, type CR 2450	

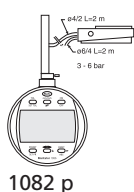

MarCator 1086 WRi

Digital Indicator



FUNCTIONS

- ON/OFF
- RESET (set display to zero)
- mm/inch
- Reversal of counting direction
- PRESET (for entering a numerical value)
- TOL (enter tolerance limit values)
- <0> (tolerance GO / NO GO display mode)
- ABS (display can be set to zero without losing reference to preset)
- DATA (data transmission via connection cable)
- Factor (adjustable)
- LOCK (individual key lock)

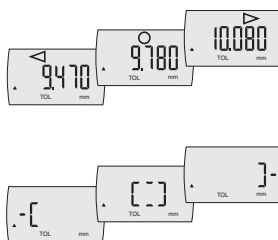

Application:

Comprehensive measuring function for static measurements such as lengths, distances and length differences

FEATURES

- Integrated wireless transmitter
- High contrast LCD
- Operating and display unit (bezel) can be rotated through 280°
- Mounting shank and measuring spindle are both made of hardened stainless steel
- Immediate measurements due to the Reference System
- **Digit height:** 11 mm
- **Data interface:** Digimatic, Opto RS232C, USB, Integrated wireless
- **IP protection category:** IP 54
- **Package contains:** instruction manual, battery

TECHNICAL DATA

Order no.	4337142	4337143
Product type	1086 WRi	
Measuring span	mm 12.5	25
Measuring span	inch .5"	1"
Resolution	0.0005, 0.001, 0.002, 0.005, 0.01	
Resolution	.00002", .00005", .0001", .0002", .0005"	
Error limit	0.004	
Error limit over 50 graduations	0.002	
Repeatability	0.001	
Measuring force	N 0.65 - 1.4	1 - 2.25
Standard	Factory standard	
Protective measuring spindle cap	•	

Order no.	a	b	c	Mounting shaft
	mm	mm	mm	mm
4337142	144.3	21	28.5	8
4337143	193.2	24.8	50	8

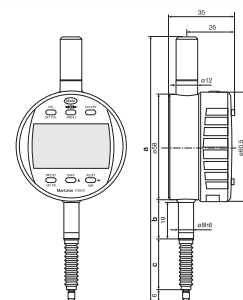

ACCESSORIES

Order no.	Product name	Product type
2246308	Adjustable back	
2254939	Screw back	
2255653	Rack back	
2255778	Adjustable back for 75B	
2255936	Post back	
4102220	Receiver for instruments with integrated wireless	i-Stick
4102357	16 EXu Data connection cable USB (2 m)	16 EXu
4102915	Digimatic data cable (2 m)	16 EWd
4102410	Data connection cable RS232C (2 m)	16 EXr
4375004	Protective cap for 1075 R / 1086 R / 1087 R	1086 s
4337421	Lug back	1086 b
4336311	Cable release (12.5 + 25 mm)	1085 a
4310103	Adapter bush (.375" / 8 mm)	940
4336237	Pneumatic lifting (12.5 + 25 mm)	1082 p
4337472-E	Rubber bellows (12.5 mm)	
4884464	Battery 3 V, type CR 2450	
4337474-E	Rubber bellows (25 mm)	

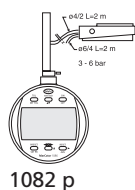

MarCator 1086 R-HR

Digital Indicator



FUNCTIONS

- ON/OFF
- RESET (set display to zero)
- mm/inch
- Reversal of counting direction
- PRESET (for entering a numerical value)
- TOL (enter tolerance limit values)
- <0> (tolerance GO / NO GO display mode)
- ABS (display can be set to zero without losing reference to preset)
- DATA (data transmission via connection cable)
- Factor (adjustable)
- LOCK (individual key lock)



Application:

High-resolution model: Resolution 0.1 µm

Extensive measuring functions for static measurements e.g. lengths, distances and length differences

FEATURES

- High contrast LCD
- Operating and display unit (bezel) can be rotated through 280°
- Lifter protection cap on the measuring spindle
- Mounting shank and measuring spindle are both made of hardened stainless steel
- Immediate measurements due to the Reference System
- Digit height: 11 mm
- Data interface: Digimatic, Opto RS232C, USB
- Energy supply: Battery life approx. 3 years
- IP protection category: IP 42
- Package contains: instruction manual, battery

TECHNICAL DATA

Order no.	4337697	4337698
Type	1086 R-HR	
Measuring span	mm 12.5	25
Measuring span inch	inch .5"	1"
Numerical increment	mm 0.0001, 0.0005, 0.001, 0.002, 0.005, 0.01	
Numerical increment	inch .00001", .00002", .00005", .0001", .0002", .0005"	
Error limit	mm 0.0018	0.0024
Error limit over 50 graduations	mm 0.0005	
Repeatability	mm 0.0005	
Measuring force	N 0.65 – 0.9	0.65 – 1.15
Standard	Factory standard	
Lifting protection cap	•	

Order no.	a	b	c	Mounting shaft
	mm	mm	mm	mm
4337697	126.3	23	13.5	8
4337698	153.4	26.8	26.5	8

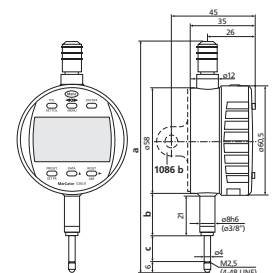

ACCESSORIES

Order no.	Product name	Product type
2246308	Adjustable back	
2254939	Screw back	
2255653	Rack back	
2255778	Adjustable back for 75B	
2255936	Post back	
4102357	16 EXu Data connection cable USB (2 m)	16 EXu
4102915	Digimatic data cable (2 m)	16 EWd
4102410	Data connection cable RS232C (2 m)	16 EXr
4375004	Protective cap for 1075 R / 1086 R / 1087 R	1086 s
4337421	Lug back	1086 b
4336311	Cable release (12.5 + 25 mm)	1085 a
4336237	Pneumatic lifting (12.5 + 25 mm)	1082 p
4310103	Adapter bush (.375" / 8 mm)	940
4884464	Battery 3 V, type CR 2450	

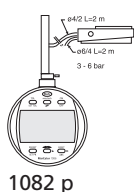

MarCator 1087 R / 1087 ZR

Digital Indicator



FUNCTIONS

- ON/OFF
- RESET (set display to zero)
- mm/inch
- Reversal of counting direction
- PRESET (for entering a numerical value)
- TOL (enter tolerance limit values)
- MAX/MIN memory for searching the reversal point
- TIR (MAX-MIN) for testing flatness and concentricity
- ABS (display can be set to zero without losing reference to preset)
- DATA (data transmission via connection cable)
- Factor (adjustable)
- LOCK (individual key lock)



Application:

Comprehensive measuring functions for:

- **Static measurements** such as lengths, distances and length differences
- **Dynamic measurements** such as radial runout, straightness and flatness via MAX / MIN / MAX-MIN functions

FEATURES

- High contrast LCD
- Operating and display unit (bezel) can be rotated through 280°
- Immediate measurements due to the Reference System
- Lifter protection cap on the measuring spindle
- Mounting shank and measuring spindle are both made of hardened stainless steel
- **Digit height:** 8.5 mm
- **Data interface:** Opto RS232C, Digimatic, USB
- **Energy supply:** Battery life approx. 3 years
- **IP protection category:** IP 42
- **Package contains:** instruction manual, battery

TECHNICAL DATA

Order no.	4337660	4337661	4337666	4337670	4337671
Product type	1087 R			1087 ZR	
Measuring span	mm	12.5	25	50	12.5
Measuring span	inch	.5"	1"	2"	.5"
Resolution	mm	0.0005, 0.001, 0.002, 0.005, 0.01			
Resolution	inch	.00002", .00005", .0001", .0002", .0005"			
Graduation values	mm	0.0005, 0.001, 0.002, 0.005, 0.01			
Range of analog display	mm	± 0.01, ± 0.02, ± 0.04, ± 0.1, ± 0.2			
Error limit	mm	0.004	0.007		0.004
Error limit over 50 graduations	mm	0.002			
Repeatability	mm	0.001			
Measuring force	N	0.65 - 0.9	0.65 - 1.15	1.25 - 2.7	0.65 - 0.9
Standard	Factory standard				
Lifting protection cap	•				

Order no.	a	b	c	Mounting shaft	Mounting shaft
	mm	mm	mm	mm	inch
4337660	126.3	23	13.5	8	
4337661	153.4	26.8	26.5	8	
4337666	267.3	40	52	8	
4337670	126.3	23	13.5		.375"
4337671	153.4	26.8	26.5		.375"

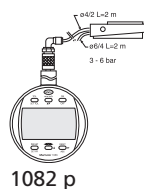
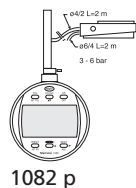
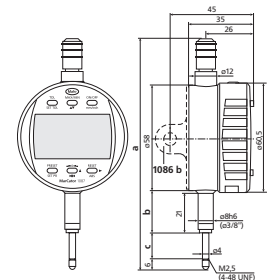

ACCESSORIES

Order no.	Product name	Product type
2246308	Adjustable back	
2254939	Screw back	
2255653	Rack back	
2255778	Adjustable back for 75B	
2255936	Post back	
4102357	16 EXu Data connection cable USB (2 m)	16 EXu
4102915	Digimatic data cable (2 m)	16 EWd
4102410	Data connection cable RS232C (2 m)	16 EXr
4375004	Protective cap for 1075 R / 1086 R / 1087 R	1086 s
4337421	Lug back	1086 b
4336237	Pneumatic lifting (12.5 + 25 mm)	1082 p
4336311	Cable release (12.5 + 25 mm)	1085 a
4310103	Adapter bush (.375" / 8 mm)	940
4884464	Battery 3 V, type CR 2450	
4336230	Pneumatic lifting (50 + 100 mm)	1082 p

MarCator 1087 Ri

Digital Indicator



FUNCTIONS

- 0 (set the analog display to zero)
- ABS (display can be set to zero without losing reference to preset)
- AUTO-ON / OFF
- DATA (data transmission via connection cable)
- Factor (adjustable)
- LOCK (individual key lock)
- MAX/MIN memory for searching the reversal point
- ON/OFF
- PRESET (for entering a numerical value)
- RANGE (switch the measuring range and resolution)
- RESET (set display to zero)
- TIR (MAX-MIN) for testing flatness and concentricity
- TOL (enter tolerance limit values)
- Reversal of counting direction
- mm/inch



Application:

Comprehensive measuring functions for:

- **Static measurements** such as lengths, distances and length differences
- **Dynamic measurements** such as radial runout, straightness and flatness via MAX / MIN / MAX-MIN functions

FEATURES

- Integrated wireless transmitter
- High-contrast LCD display
- Operating and display unit (bezel) can be rotated through 280°
- Lifter protection cap on the measuring spindle
- Clamping shaft and measuring pin made of hardened stainless steel
- Immediate measurements due to the Reference System
- **Digit height:** 8.5 mm
- **Data interface:** Digimatic, Opto RS232C, USB, Integrated wireless
- **Energy supply:** Battery operation
- **IP protection category:** IP 42
- **Package contains:** instruction manual, battery

TECHNICAL DATA

Order no.	4337663	4337665	4337667	
Product type	1087 Ri			
Measuring span	mm	12.5	25	50
Measuring span	inch	.5"	1"	2"
Resolution	mm	0.0005, 0.001, 0.002, 0.005, 0.01		
Resolution	inch	.00002", .00005", .0001", .0002", .0005"		
Graduation values	mm	0.0005, 0.001, 0.002, 0.005, 0.01		
Range of analog display	mm	± 0.01, ± 0.02, ± 0.04, ± 0.1, ± 0.2		
Error limit	mm	0.004		0.007
Error limit over 50 graduations	mm	0.002		
Repeatability	mm	0.001		
Measuring force	N	0.65 - 0.85	0.65 - 0.9	1.25 - 2.7
Standard	Factory standard			
Lifting protection cap	•			

Order no.	a	b	c	Mounting shaft
	mm	mm	mm	mm
4337663	126.3	23	13.5	8
4337665	153.4	26.8	26.5	8
4337667	267.3	40	52	8

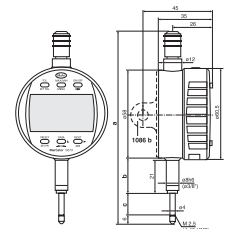

ACCESSORIES

Order no.	Product name	Product type
2246308	Adjustable back	
2254939	Screw back	
2255653	Rack back	
2255778	Adjustable back for 75B	
2255936	Post back	
4102220	Receiver for instruments with integrated wireless	i-Stick
4102357	16 EXu Data connection cable USB (2 m)	16 EXu
4102915	Digimatic data cable (2 m)	16 EWd
4102410	Data connection cable RS232C (2 m)	16 EXr
4375004	Protective cap for 1075 R / 1086 R / 1087 R	1086 s
4337421	Lug back	1086 b
4336237	Pneumatic lifting (12.5 + 25 mm)	1082 p
4336311	Cable release (12.5 + 25 mm)	1085 a
4310103	Adapter bush (.375" / 8 mm)	940
4884464	Battery 3 V, type CR 2450	
4336230	Pneumatic lifting (50 + 100 mm)	1082 p

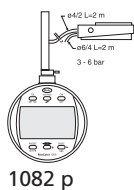

1082 p

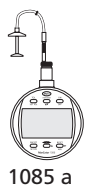

1085 a

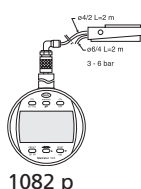

1082 p

MarCator 1087 R-HR

Digital Indicator



FUNCTIONS

- ON/OFF
- RESET (set display to zero)
- mm/inch
- Reversal of counting direction
- PRESET (for entering a numerical value)
- TOL (enter tolerance limit values)
- MAX/MIN memory for searching the reversal point
- TIR (MAX-MIN) for testing flatness and concentricity
- ABS (display can be set to zero without losing reference to preset)
- DATA (data transmission via connection cable)
- Factor (adjustable)
- LOCK (individual key lock)



Application:

High-resolution model: Resolution 0.1 μm

Extensive measuring functions for:

- Static measurements e.g. lengths, distances and length differences
- Dynamic measurements e.g. radial run-out, straightness and flatness, by means of MAX / MIN / MAX-MIN functions

FEATURES

- High contrast LCD
- Operating and display unit (bezel) can be rotated through 280°
- Immediate measurements due to the Reference System
- Lifter protection cap on the measuring spindle
- Mounting shank and measuring spindle are both made of hardened stainless steel
- Digit height: 8.5 mm
- Data interface: Opto RS232C, Digimatic, USB
- Energy supply: Battery life approx. 3 years
- IP protection category: IP 42
- Package contains: instruction manual, battery

TECHNICAL DATA

Order no.	4337695	4337696
Type	1087 R-HR	
Measuring span	mm 12.5	25
Measuring span inch	inch .5"	1"
Numerical increment	mm 0.0001, 0.0005, 0.001, 0.002, 0.005, 0.01	
Numerical increment	inch .00001", .00002", .00005", .0001", .0002", .0005"	
Range of analog display	mm ± 0.002, ± 0.01, ± 0.02, ± 0.04, ± 0.1, ± 0.2	
Error limit	mm 0.0018	0.0024
Error limit over 50 graduations	mm 0.0005	
Repeatability	mm 0.0005	
Measuring force	N 0.65 - 0.9	0.65 - 1.15
Standard	Factory standard	
Lifting protection cap	•	

Order no.	a	b	c	Mounting shaft
	mm	mm	mm	mm
4337695	126.3	23	13.5	8
4337696	153.4	26.8	26.5	8

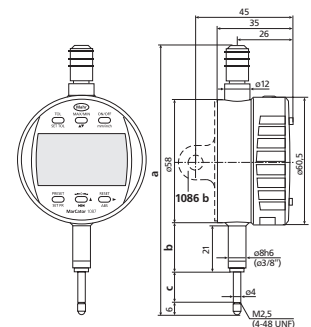

ACCESSORIES

Order no.	Product name	Product type
2246308	Adjustable back	
2254939	Screw back	
2255653	Rack back	
2255778	Adjustable back for 75B	
2255936	Post back	
4102357	16 EXu Data connection cable USB (2 m)	16 EXu
4102915	Digimatic data cable (2 m)	16 EWd
4102410	Data connection cable RS232C (2 m)	16 EXr
4375004	Protective cap for 1075 R / 1086 R / 1087 R	1086 s
4337421	Lug back	1086 b
4336311	Cable release (12.5 + 25 mm)	1085 a
4336237	Pneumatic lifting (12.5 + 25 mm)	1082 p
4310103	Adapter bush (.375" / 8 mm)	940
4884464	Battery 3 V, type CR 2450	

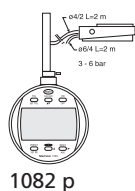

MarCator 1087 BR

Digital Indicator



FUNCTIONS

- ON/OFF
- RESET (set display to zero)
- mm/inch
- PRESET (for entering a numerical value)
- Reversal of counting direction
- TOL (enter tolerance limit values)
- START/STOP search for reversal point
- MAX/MIN memory for searching the reversal point
- ABS (display can be set to zero without losing reference to preset)
- 0 (set the analog display to zero)
- DATA (data transmission via connection cable)
- Factor (adjustable)

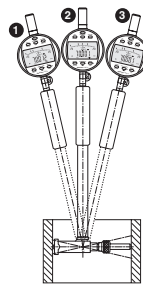

Application:

- In measurements with a 2-point bore gage the reversing point can be calculated automatically during oscillation. Then a PRESET value can be assigned.
- The ACTUAL value measured is saved by the MIN or MAX function and is shown on the display.
- The 1087 BR model can process 64 measured values per second, for fast measuring movements combined with measuring certainty.

FEATURES

- High contrast LCD
- Operating and display unit (bezel) can be rotated through 280°
- Immediate measurements due to the Reference System
- Mounting shank and measuring spindle are both made of hardened stainless steel
- Protection cap on the end of measuring spindle
- Digit height: 8.5 mm
- Data interface: Opto RS232C, Digimatic, USB
- Energy supply: Battery life approx. 3 years
- IP protection category: IP 42
- Package contains: instruction manual, battery

TECHNICAL DATA

Order no.	4337662	
Product type	1087 BR	
Measuring span	mm	12.5
Measuring span	inch	.5"
Resolution	mm	0.0005, 0.001, 0.002, 0.005, 0.01
Resolution	inch	.00002", .00005", .0001", .0002", .0005"
Graduation values	mm	0.0005, 0.001, 0.002, 0.005, 0.01
Range of analog display	mm	± 0.01, ± 0.02, ± 0.04, ± 0.1, ± 0.2
Error limit	mm	0.004
Error limit over 50 graduations	mm	0.002
Repeatability	mm	0.001
Measuring force	N	0.65 - 0.9
Standard	Factory standard	
Protective measuring spindle cap	•	

Order no.	a	b	c	Mounting shaft
	mm	mm	mm	mm
4337662	126.3	23	13.5	8

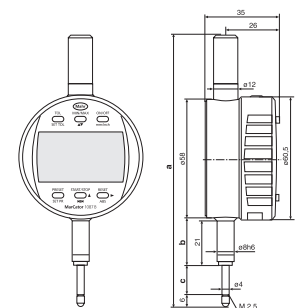

ACCESSORIES

Order no.	Product name	Product type
2246308	Adjustable back	
2254939	Screw back	
2255653	Rack back	
2255778	Adjustable back for 75B	
2255936	Post back	
4102357	16 EXu Data connection cable USB (2 m)	16 EXu
4102915	Digimatic data cable (2 m)	16 EWd
4102410	Data connection cable RS232C (2 m)	16 EXr
4375004	Protective cap for 1075 R / 1086 R / 1087 R	1086 s
4310103	Adapter bush (.375" / 8 mm)	940
4884464	Battery 3 V, type CR 2450	

MarCator 1087 BRi

Digital Indicator



FUNCTIONS

- ON/OFF
- RESET (set display to zero)
- mm/inch
- PRESET (enter anumerical value) from range 500 mm
- Reversal of counting direction
- TOL (enter tolerance limit values)
- START/STOP search for reversal point
- MAX/MIN memory for searching the reversal point
- ABS (display can be set to zero without losing reference to preset)
- 0 (set the analog display to zero)
- DATA (data transmission via connection cable)
- Factor (adjustable)
- LOCK (individual key lock)

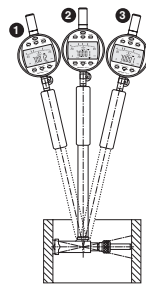

Application:

- In measurements with a 2-point bore gage the reversing point can be calculated automatically during oscillation. Then a PRESET value can be assigned.
- The ACTUAL value measured is saved by the MIN or MAX function and is shown on the display.
- The 1087 BRi model can process 64 measured values per second, for fast measuring movements combined with measuring certainty.

FEATURES

- Integrated wireless transmitter
- High-contrast LCD display
- Operating and display unit (bezel) can be rotated through 280°
- Lifter protection cap on the measuring spindle
- Clamping shaft and measuring pin made of hardened stainless steel
- Immediate measurements due to the Reference System
- **Digit height:** 8.5 mm
- **Data interface:** Opto RS232C, Digimatic, USB, Integrated wireless
- **Energy supply:** Battery life approx. 3 years
- **IP protection category:** IP 42
- **Package contains:** instruction manual, battery

TECHNICAL DATA

Order no.	4337664	
Product type	1087 BRi	
Measuring span	mm	12.5
Measuring span	inch	.5"
Resolution	mm	0.0005, 0.001, 0.002, 0.005, 0.01
Resolution	inch	.00002", .00005", .0001", .0002", .0005"
Graduation values	mm	0.0005, 0.001, 0.002, 0.005, 0.01
Range of analog display	mm	± 0.01, ± 0.02, ± 0.04, ± 0.1, ± 0.2
Error limit	mm	0.004
Error limit over 50 graduations	mm	0.002
Repeatability	mm	0.001
Measuring force	N	0.65 – 0.9
Standard	Factory standard	
Protective measuring spindle cap	•	

Order no.	a	b	c	Mounting shaft
	mm	mm	mm	mm
4337664	126.3	23	13.5	8

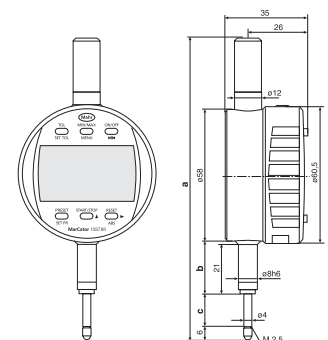

ACCESSORIES

Order no.	Product name	Product type
2246308	Adjustable back	
2254939	Screw back	
2255653	Rack back	
2255778	Adjustable back for 75B	
2255936	Post back	
4102220	Receiver for instruments with integrated wireless	i-Stick
4102357	16 EXu Data connection cable USB (2 m)	16 EXu
4102915	Digimatic data cable (2 m)	16 EWd
4102410	Data connection cable RS232C (2 m)	16 EXr
4375004	Protective cap for 1075 R / 1086 R / 1087 R	1086 s
4310103	Adapter bush (.375" / 8 mm)	940
4884464	Battery 3 V, type CR 2450	